

**CROM**  
**Θ2**



**CONTRACT**

**MOBILIARIO**  
**MOBILIARI**  
**FURNITURE**  
**MOBILIER**

CROM.  
-02

# CHAIRS



- 04 VINTAGE
- 10 DOTS
- 18 LOLI
- 22 MAGISTER
- 28 GAUDÍ
- 30 VICHY
- 34 APTA
- 36 TONIX
- 40 ARCS
- 44 VINT
- 46 ELIPTICA
- 48 CUBICA
- 51 ATENAS
- 52 ETNA
- 54 SUSHI
- 56 CARLA
- 58 OLIMPIA
- 60 HELENA
- 62 LAURA
- 64 CAPRI
- 66 RETRO
- 70 SALÓN
- 72 MADERA
- 76 HANDY
- 77 PACKS
- 78 BÁSICAS
- 82 EDU
- 88 BANCADAS
- 90 94AF
- 91 MAMPARAS

# BARSTOOL



- 92 TWIST
- 94 CONIC
- 95 LAB
- 96 DUAL
- 97 MAGISTER
- 98 CARLA
- 100 ATENAS
- 101 ETNA
- 102 SUSHI
- 104 OLIMPIA
- 106 HELENA
- 108 CAPRI
- 110 LIDO
- 112 CUBICA
- 114 GIRATORIO
- 115 SQUARE
- 116 1600
- 117 VINT
- 118 1630
- 119 1640
- 120 BÁSICOS
- 122 1001
- 123 1002
- 124 1500
- 125 1061

# TABLE



- 126 2006
- 128 BÁSICAS
- 132 2520
- 133 TWIN
- 134 PARIS
- 135 4150
- 136 FUNDICIÓN
- 138 BASES ACERO
- 140 TUBO
- 144 2029-2009
- 146 4027
- 148 2025
- 149 2500AR
- 150 PLEGABLES

- 
- 154 CANTOS Y TAPAS
  - 156 ACABADOS



UNLIMITED FINISHES



# TAGE



# VINTAGE

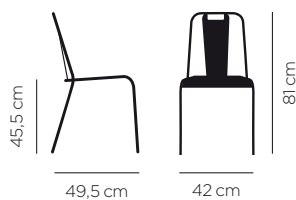

## VINTAGE

Silla apilable / Cadira apilable / Stackable chair / Chaise empilable

### Ref. 3000

Asiento acero  
Seient d' acer  
Steel seat  
Assise acier

### Ref. 3001

Asiento formica  
Seient Formica  
Formica seat  
Assise formica

### Ref. 3002

Asiento madera barnizada  
Seient fusta tintada  
Wooden stained seat  
Assise Bois teinté

 4,12 kg





UNLIMITED FINISHES

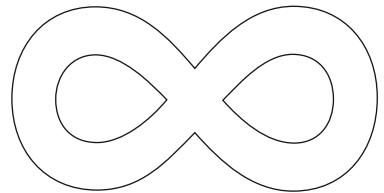

## VINTAGE

Silla apilable / Cadira apilable  
Stackable chair / Chaise empilable

### Ref. 3004

Asiento tapizado  
Seient entapissat  
Upholstered seat  
Assise garnie

 4,12 kg



# VINTAGE







# GE



## VINTAGE

Silla apilable / Cadira apilable  
Stackable chair / Chaise empilable

**Ref. 3000**  
Asiento acero  
Seient d' acer  
Steel seat  
Assise acier

 4,12 kg

# DOTS

3008



## DOTS

Silla apilable / Cadira apilable  
Stackable chair / Chaise empilable

Ref. 3008

5,34 kg

Asiento metálico / Seient metàlic  
Steel seat / Assise metal

5,20 kg

Asiento formica / Seient de formica  
Formica seat / Assise formica

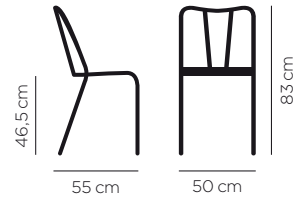



## DOTS

Taburete / Tamboret  
Barstool / Tabouret

Ref. 3010

📏 6,96 kg

Asiento metálico / Seient metàlic  
Steel seat / Assise metal

📏 6,84 kg

Asiento formica / Seient de formica  
Formica seat / Assise formica

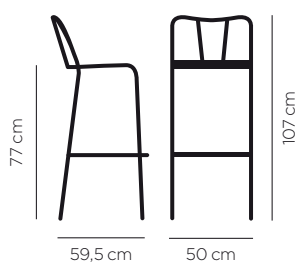

# DOTS

3010



# DOTS

3009



## DOTS

Sillón apilable / Butaca apil-lable  
Stackable steel arm chair / Fauteuil empilable

Ref. 3009

6,24 kg

Asiento metálico / Seient metàlic  
Steel seat / Assise metal

6,10 kg

Asiento formica / Seient de formica  
Formica seat / Assise formica

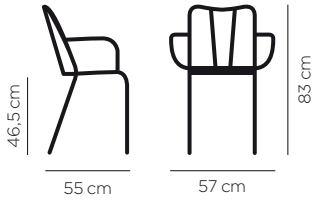



## DOTS

Taburete con brazos / Tamboret amb braços  
Barstool with armrest / Tabouret avec accoudoirs

Ref. 3011

👤 7,84 kg

Asiento metálico / Seient metàlic  
Steel seat / Assise metal

👤 7,72 kg

Asiento formica / Seient de formica  
Formica seat / Assise formica

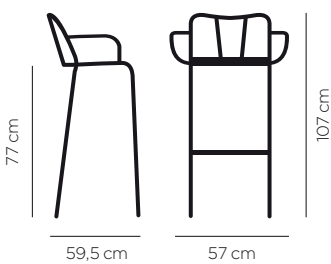



# DOTS

3011





LOLLI 2979

# LOLI

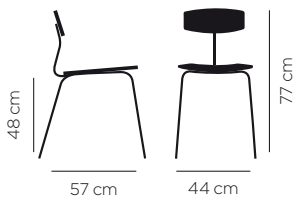

## LOLI

Silla apilable / Cadira apilable  
Stackable chair / Chaise empilable

### Ref. 2979

Asiento y respaldo madera tintada  
Seient i respalller de fusta tintada  
Stained wooden seat and back rest  
Assise et dossier bois teinté

 4,46 kg







M M A A G I



STER 917 R



M M A G I





# STAIR

1918F

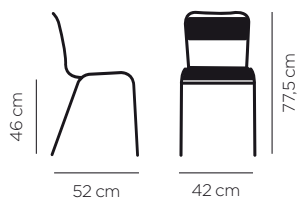

## MAGISTER

Silla apilable / Cadira apilable  
Stackable chair / Chaise empilable

### Ref. 917

Asiento y Respaldo formica o madera  
Seient i respalller formica o fusta  
Formica or wooden seat and back rest  
Assise et dossier bois teinté ou Formica

 4,78 kg

# MAGISTER

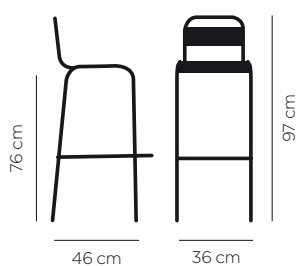

## MAGISTER

Taburete / Tamboret  
Barstool / Tabouret

### Ref. 1918F

Asiento y Respaldo formica o madera  
Seient i respatllet formica o fusta  
Formica or wooden seat and back rest  
Assise et dossier bois teinté ou Formica

 5,14 kg



Q A U I



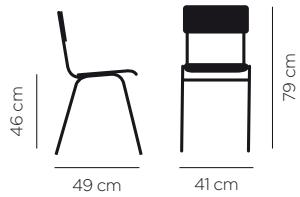

## GAUDÍ

Silla apilable / Cadira apilable  
Stackable chair / Chaise empilable

### Ref. 98 G

Asiento y respaldo formica Gaudí  
Seient i respatllet de formica Gaudí  
Formica Gaudí seat and back rest  
Assise et dossier formica Gaudí

📊 4,32 kg



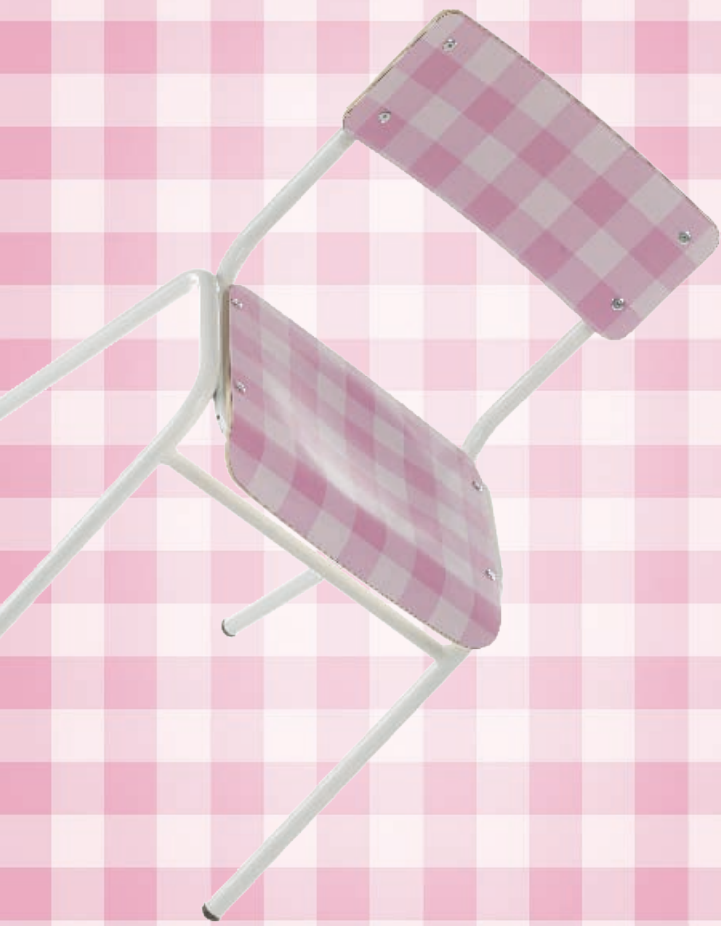

WM

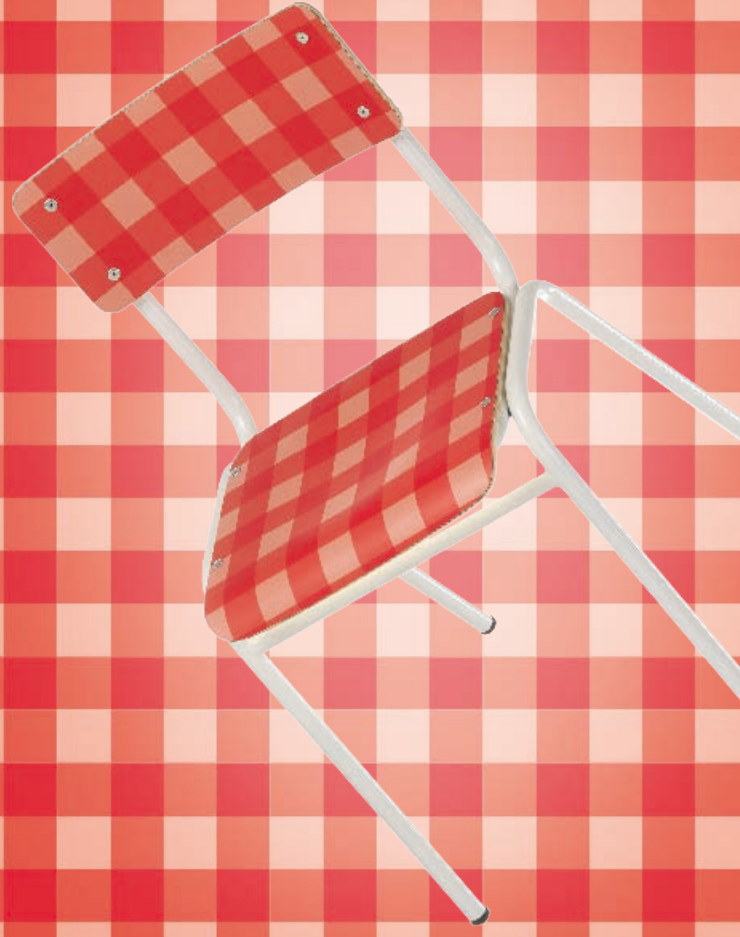

**C**

**H**

**Y**

# VICHY

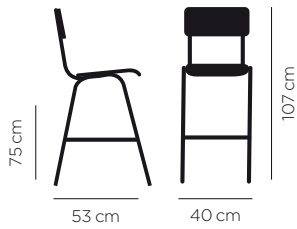

## VICHY

Taburete / Tamboret  
Barstool / Tabouret

### Ref. 1099

Asiento y respaldo formica Vichy  
Seient i respàtller de formica Vichy  
Formica Vichy seat and back rest  
Assise et dossier formica Vichy

 5,70 kg





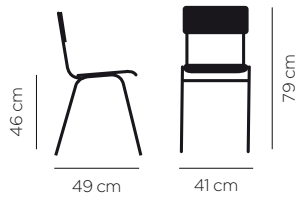

**VICHY**  
Silla apilable / Cadira apilable  
Stackable chair / Chaise empilable

**Ref 98**  
Asiento y respaldo formica Vichy  
Seient i respattler de formica Vichy  
Formica Vichy seat and back rest  
Assise et dossier formica Vichy

 4,32 kg





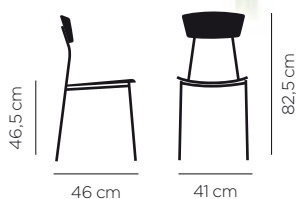

**APTA**  
Silla apilable / Cadira apilable  
Stackable chair / Chaise empilable

**Ref. 2980**  
Madera / Formica  
Fusta / Estratificat  
Wood / HPL  
Bois / Stratifié

 3,83 kg

# APTA





# TONIX

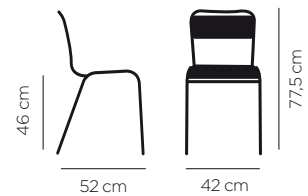

## TONIX

Respaldo de chapa de acero

Respatller de xapa d'acer

Steel backrest

Dossier acier

Ref. 916

 5,88 kg

# TONIX

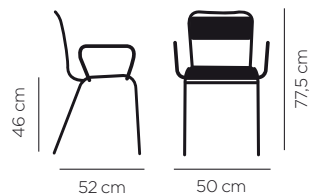

## TONIX CB

Respaldo de chapa de acero

Respatller de xapa d'acer

Steel backrest

Dossier acier

Ref. 916 CB

 7,18 kg





# ARBR





# U S

# ARCS

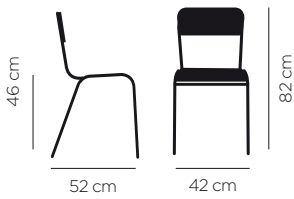

## ARCS

Silla apilable / Cadira apilable  
Stackable chair / Chaise empilable

### Ref. 911

Asiento y respaldo formica o madera  
Seient i respalller de formica o fusta  
Formica or wooden seat and back rest  
Assise et dossier bois teinté ou formica

 4,92 kg







## VINT

Silla / Cadira  
Chair / Chaise

### Ref. 3003

Asiento y respaldo madera tintada  
Seient i respàtller de fusta tintada  
Stained wooden seat and back rest  
Assise et dossier bois teinté

 4,74 kg



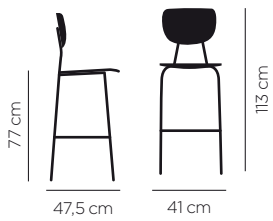

## VINT

Taburete / Tamboret  
Barstool / Tabouret

### Ref. V520

Asiento y respaldo madera tintada  
Seient i respalller de fusta tintada  
Stained wooden seat and back rest  
Assise et dossier bois teinté

6,34 kg



# ELIPTICA



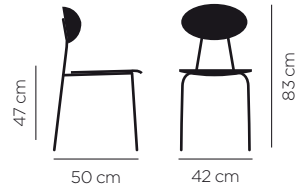

**ELIPTICA**  
Silla / Cadira  
Chair / Chaise

**Ref. 3004**

Asiento y respaldo madera tintada  
Seient i respalller de fusta tintada  
Stained wooden seat and back rest  
Assise et dossier bois teinté

 4,70 kg

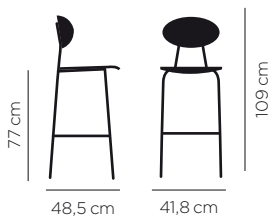

**ELIPTICA**  
Taburete / Tamboret  
Barstool / Tabouret

**Ref. v521**

Asiento y respaldo madera tintada  
Seient i respalller de fusta tintada  
Stained wooden seat and back rest  
Assise et dossier bois teinté

 6,34 kg



# CUBICA



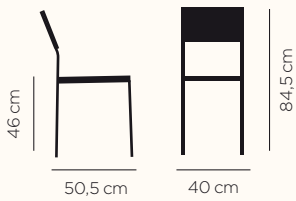

## CUBICA

Silla apilable / Cadira apilable  
Stackable chair / Chaise empilable

Ref. 2988

 4,48 kg



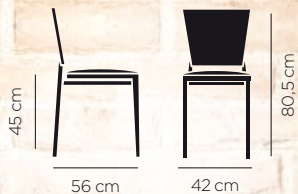

**ATENAS**  
Silla / Cadira / Chair / Chaise

**Ref. 2985**  
Silla mixta.  
Cadira mixta  
Combined chair  
Chaise mixte

 6,24 kg

ATENAS

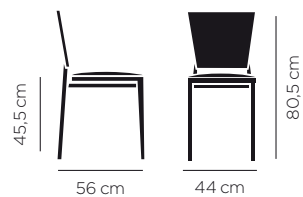

**ATENAS**  
Silla / Cadira / Chair / Chaise

**Ref. 2982**  
Silla mixta  
Cadira mixta  
Combined chair  
Chaise mixte

 6,82 kg

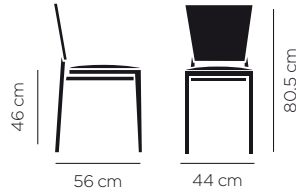

## ATENAS

Silla / Cadira / Chair / Chaise

### Ref. 2983

Silla mixta tapizada  
Cadira mixta entapissada  
Combined chair upholstered seat  
Chaise mixte assise garnie

 6,90 kg

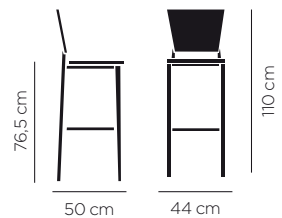

## ATENAS

Taburete / Tamboret  
Barstool / Tabouret

### Ref. 9583

Taburete mixto haya/acero  
Tamboret mixte faig/acer  
Combined barstool beech/steel  
Tabouret mixte hêtre/acier

 8,14 kg

ATENAS

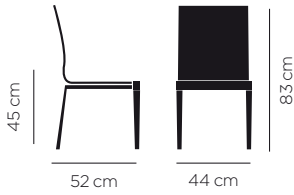

## ETNA

Silla / Cadira / Chair / Chaise

### Ref. 2984

Silla mixta haya / acero.  
 Cadira mixta faig / acer.  
 Combined chair beech / steel.  
 Chaise mixte hêtre / acier.

6,32 kg

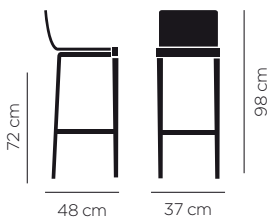

## ETNA

Taburete / Tamboret  
 Barstool / Tabouret

### Ref. 9579

Taburete mixto haya / acero.  
 Tamboret mixte faig / acer.  
 Combined barstool beech / steel.  
 Tabouret mixte hêtre / acier.

7,34 kg

# FINNA





# SUSHI

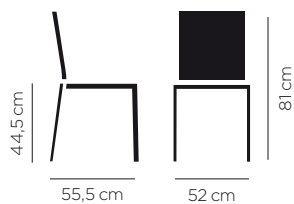

## SUSHI

Silla / Cadira / Chair / Chaise

### Ref. 2971R

Silla apilable con ranura  
Cadira apil.lable amb ranura  
Stackable chair  
Chaise empilable

 6,48 kg





# CARLA

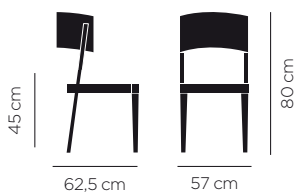

## CARLA

Silla / Cadira / Chair / Chaise

**Ref. 2976**  
Silla mixta haya/acero  
Cadira mixta faig/acer  
Combined chair beech/steel  
Chaise mixte hêtre/acier

 6,90 kg

## CARLA

Silla / Cadira / Chair / Chaise

**Ref. 2976T**  
Silla mixta haya/acero. Asiento tapizado  
Cadira mixta faig/acer. Seient entapissat  
Combined chair beech/steel. Upholstered seat  
Chaise mixte hêtre/acier. Assise garnie

 7,72 kg







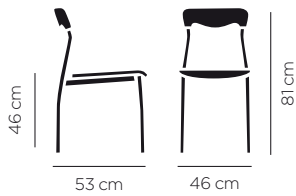

## OLIMPIA

Silla mixta / Cadira mixta  
Combined chair / Chaise mixte

### Ref. 9433 (wood)

Silla mixta haya/acero  
Cadira mixta faig/acer  
Combined chair beech/steel  
Chaise mixte hêtre/acier

5,42 kg

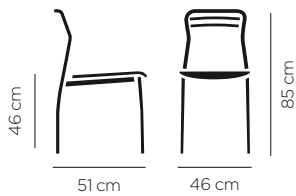

## OLIMPIA

Silla mixta / Cadira mixta  
Combined chair / Chaise mixte

### Ref. 9433 (metallic)

Silla mixta acero  
Cadira mixta acer  
Combined chair steel  
Chaise mixte acier

5,48 kg



# HELENA



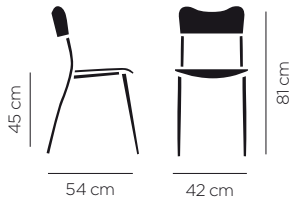

## HELENA

Silla apilable / Cadira apilable  
Stackable chair / Chaise empilable

Ref. 9520

Silla mixta  
Cadira mixta  
Combined chair  
Chaise mixte

 4,88 kg



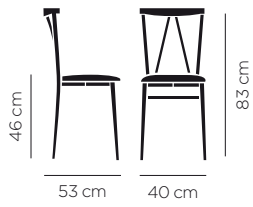

## LAURA

Silla apilable / Cadira apilable  
Stackable chair / Chaise empilable

### Ref. 9510

Silla mixta.  
Cadira mixta.  
Combined chair.  
Chaise mixte.

 4,60 kg





# LAURBA

# CAPRI

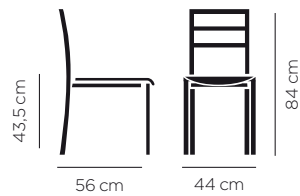

## CAPRI

Silla / Cadira / Chair / Chaise

### Ref. 2975 T

Silla mixta tapizada / acero.  
Cadira mixta entapissada / acer.  
Combined chair upholstered seat / steel.  
Chaise mixte Assise garnie / acier.

 6,64 kg



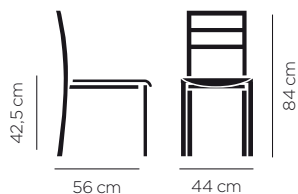

## CAPRI

Silla / Cadira / Chair / Chaise

### Ref. 2975

Silla mixta haya / acero.  
 Cadira mixta faig / acer.  
 Combined chair beech / steel.  
 Chaise mixte hêtre / acier.

 6,64 kg

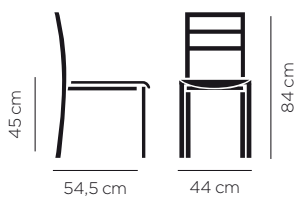

## CAPRI

Silla / Cadira / Chair / Chaise

### Ref. 2973

Silla mixta haya / acero.  
 Cadira mixta faig / acer.  
 Combined chair beech / steel.  
 Chaise mixte hêtre / acier.

 7,72 kg

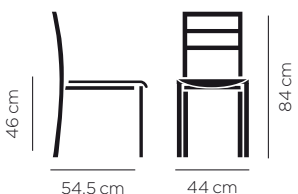

## CAPRI

Silla / Cadira / Chair / Chaise

### Ref. 2974

Silla mixta haya / acero. Asiento tapizado.  
 Cadira mixta faig / acer. Seient entapissat.  
 Combined chair beech / steel. Upholstered seat.  
 Chaise mixte hêtre / acier. Assise garnie.

 8,52 kg

# RETRO



# UNLIMIT



# TED FINISHES



## RETRO

Silla apilable / Cadira apilable  
Stackable chair / Chaise empilable

### Ref. 206

Silla apilable tapizada. Acabados infinitos.

Cadeira apilable entapissada.

Upholstered stackable chair.

Chaise garnie empilable.

 6 kg



# UNLIMITED FINISHES

# RETRO



# SALÓN

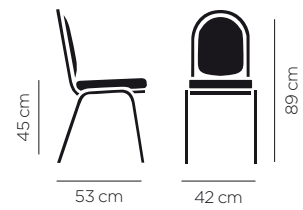

## SALÓN

Silla apilable / Cadira apilable  
Stackable chair / Chaise empilable

### Ref. 902

Silla tapizada / Cadira entapissada  
Upholstered chair / Chaise tapissée

 7,46 kg

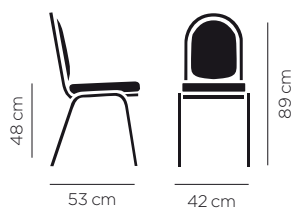

## SALÓN

Silla apilable / Cadira apilable  
Stackable chair / Chaise empilable

### Ref. 903

Silla tapizada / Cadira entapissada  
Upholstered chair / Chaise tapissée

 7,66 kg



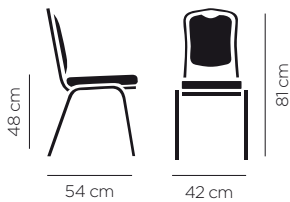

### SALÓN

Silla apilable / Cadira apilable  
Stackable chair / Chaise empilable

Ref. 905

Silla tapizada / Cadira entapissada  
Upholstered chair / Chaise tapissée

7,96 kg

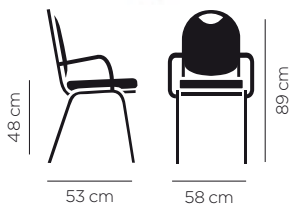

### SALÓN

Silla apilable / Cadira apilable  
Stackable chair / Chaise empilable

Ref. 904 C/B

Silla tapizada / Cadira entapissada  
Upholstered chair / Chaise tapissée

9,68 kg

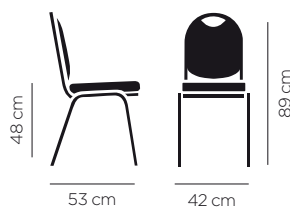

### SALÓN

Silla apilable / Cadira apilable  
Stackable chair / Chaise empilable

Ref. 904

Silla tapizada / Cadira entapissada  
Upholstered chair / Chaise tapissée

7,76 kg





**9468**  
Silla / Cadira / Chair / Chaise

Ref. 9468

 3,74 kg

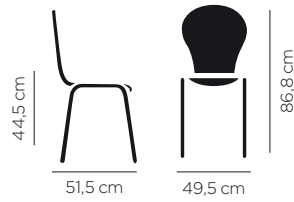

**9467**  
Silla / Cadira / Chair / Chaise

Ref. 9467

 3,92 kg





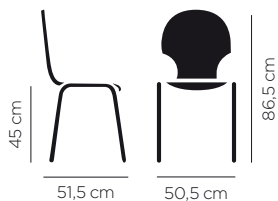

**9466**  
Silla / Cadira / Chair / Chaise

Ref. 9466

 4,12 kg

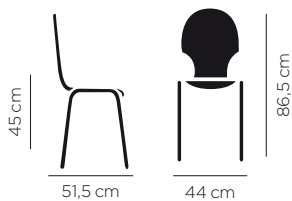

**9465**  
Silla / Cadira / Chair / Chaise

Ref. 9465

 4,68 kg



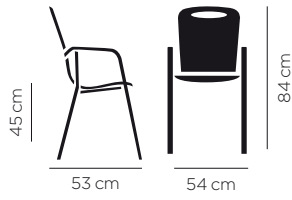

**GREGO**  
Silla / Cadira  
Chair / Chaise

Ref. 2967

 6,94 kg

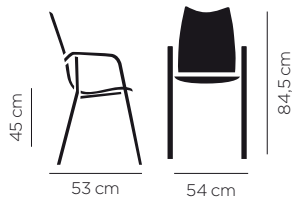

**PASTOR**  
Silla / Cadira  
Chair / Chaise

Ref. 2966

 7,08 kg



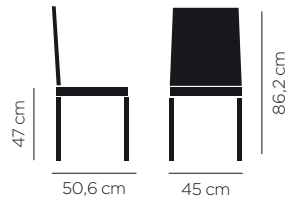

## FÉNIX

Silla / Cadira  
Chair / Chaise

Ref. 2977

 4,26 kg



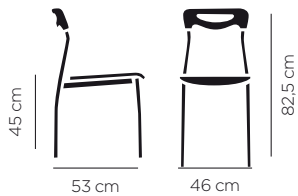

## HANDY

Silla / Cadira / Chair / Chaise

### Ref. 2934

Silla mixta Acero / madera  
 Cadira mixta. Acer / fusta  
 Combined chair. Steel / wood  
 Chaise mixte . Acier / bois.

 4,20 kg

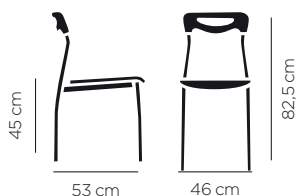

## HANDY

Silla / Cadira / Chair / Chaise

### Ref. 2934

Silla mixta Acero / madera Asiento tapizado  
 Cadira mixta. Acer / fusta. Seient entapissat  
 Combined chair. Steel / wood. Upholstered seat  
 Chaise mixte . Acier / bois. Assise garnie

 5,28 kg

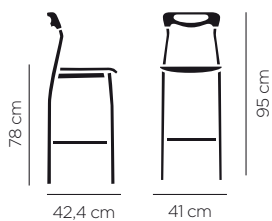

## HANDY

Taburete / Tamboret  
 Barstool / Tabouret

### Ref. 2956

Taburete mixto haya / acero o tapizado  
 Tamboret mixte faig / acer o entapissat  
 Combined barstool beech / Steel or upholstered  
 Tabouret mixte hêtre / acier ou garnie

 6,50 kg



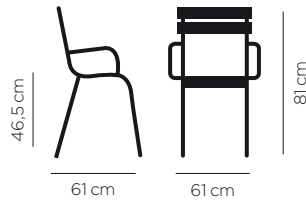

**PLACKS**  
Silla apilable / Cadira apilable  
Stackable chair / Chaise empilable

**Ref. 602CB**  
Silla acero  
Cadira d' acer  
Steel chair  
Chaise acier

 8,70 kg

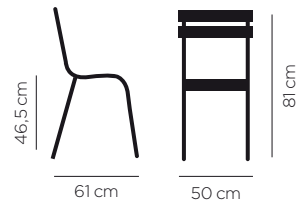

**PLACKS**  
Silla apilable / Cadira apilable  
Stackable chair / Chaise empilable

**Ref. 602**  
Silla acero  
Cadira d' acer  
Steel chair  
Chaise acier

 7 kg



PLACKS

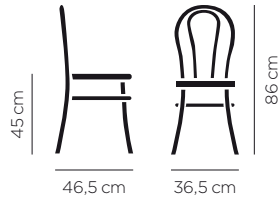

**601**

**Silla / Cadira / Chair / Chaise**

**Ref. 601**

Estructura de acero.  
Estructura d' acer.  
Steel frame.  
Structure acier.

 4,22 kg

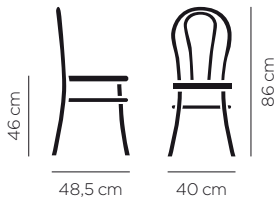

**603**

**Silla / Cadira / Chair / Chaise**

**Ref. 603**

Estructura de acero / Asiento tapizado o de madera.  
Estructura d' acer / Seient entapissat o de fusta.  
Steel frame. Upholstered / wooden seat.  
Structure acier. Assise garnie / bois.

 5,32 kg

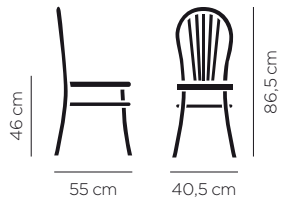

**501**  
Silla / Cadira / Chair / Chaise

**Ref. 501**  
Estructura de acero / Asiento tapizado o de madera.  
Estructura d'acer / Seient entapissat o de fusta.  
Steel frame. Upholstered / wooden seat.  
Structure acier. Assise garnie / bois.

 5,42 kg



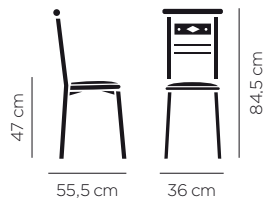

## 2109

Silla / Cadira / Chair / Chaise

### Ref. 2109

Estructura de acero. Asiento tapizado / madera  
Estructura d' acer. Seient entapissat / fusta  
Steel frame. Upholstered / wooden seat.  
Structure acier. Assise garnie/ bois.

5,92 kg

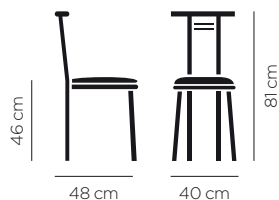

## 108

Silla / Cadira / Chair / Chaise

### Ref. 108

Estructura de acero. Asiento tapizado.  
Estructura d' acer. Seient entapissat.  
Steel frame. Upholstered seat.  
Structure acier. Assise garnie.

5,12 kg

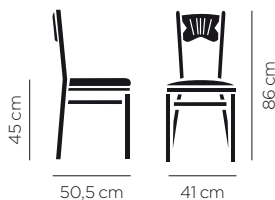

## 205

Silla / Cadira / Chair / Chaise

### Ref. 205

Estructura de acero. Asiento tapizado.  
Estructura d' acer. Seient entapissat.  
Steel frame. Upholstered seat.  
Structure acier. Assise garnie.

7,18 kg





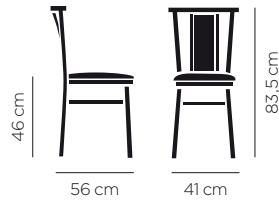

**207**

**Silla / Cadira / Chair / Chaise**

**Ref. 207**

Estructura de acero. Asiento y Respaldo tapizados.  
Estructura d' acer. Seient i respatlles entapissats.  
Steel frame. Upholstered seat and backrest.  
Structure acier. Assise et dossier garnies.

 7,88 kg

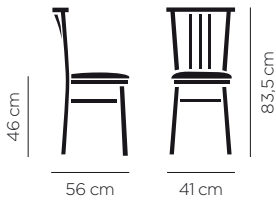

**208**

**Silla / Cadira / Chair / Chaise**

**Ref. 208**

Estructura de acero. Asiento tapizado.  
Estructura d' acer. Seient entapissat.  
Steel frame. Upholstered seat.  
Structure acier. Assise garnie.

 7,56 kg

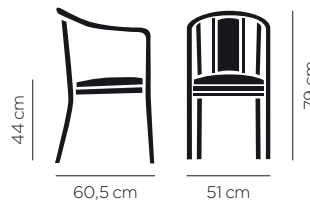

**304**

**Sillón/ sillonet/ armchair/ fauteuil**

**Ref. 304**

Estructura de acero. Asiento y respaldo tapizado.  
Estructura d' acer. Seient i respatlles entapissats.  
Steel frame. Upholstered seat and backrest  
Structure acier. Assise et dossier garnies.

 8,46 kg





**EDU**  
 Silla apilable / Cadira apilable  
 Stackable chair / Chaise empilable

**Ref. 702**  
 Antideslizante / Antiliscant  
 Anti-slip / Antidérapage



**EDU**  
 Silla apilable / Cadira apilable  
 Stackable chair / Chaise empilable

**Ref. 703**



**EDU**  
 Silla apilable / Cadira apilable  
 Stackable chair / Chaise empilable

**Ref. 9571**

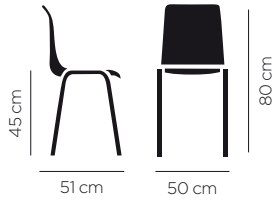

**EDU**  
 Silla apilable / Cadira apilable  
 Stackable chair / Chaise empilable  
 Ref. 9570

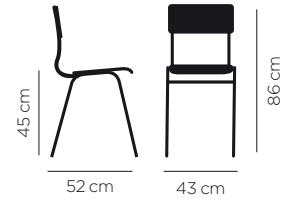

**EDU**  
 Silla / Cadira / Chair / Chaise  
 Ref. 919  
 Silla formica anatómica  
 Cadira formica anatòmica  
 Anatomical chair  
 Chaise anatomique

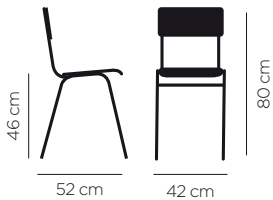

**EDU**  
 Silla apilable / Cadira apilable  
 Stackable chair / Chaise empilable  
 Ref. 98  
 Silla formica apilable  
 Cadira formica apilable  
 Stackable chair  
 Chaise empilable



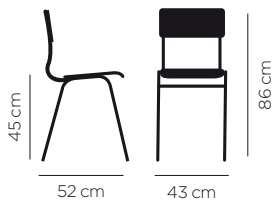

**EDU**  
 Silla / Cadira / Chair / Chaise  
 Ref. 919



**EDU**  
 Silla apilable / Cadira apilable  
 Stackable chair / Chaise empilable  
 Ref. 918

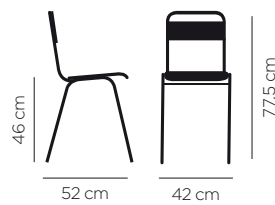

**EDU**  
 Silla / Cadira / Chair / Chaise  
 Ref. 917



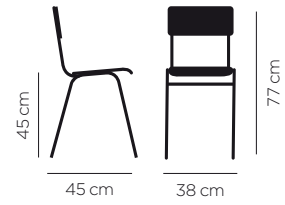

**EDU**  
 Silla / Cadira / Chair / Chaise  
 Ref. 99

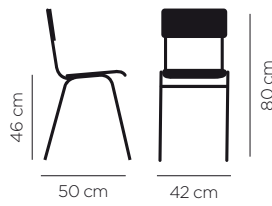

**EDU**  
 Silla apilable / Cadira apilable  
 Stackable chair / Chaise empilable  
 Ref. 98

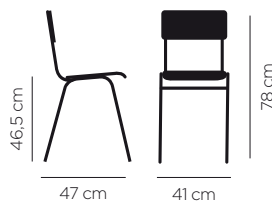

**EDU**  
 Silla apilable / Cadira apilable  
 Stackable chair / Chaise empilable  
 Ref. 97



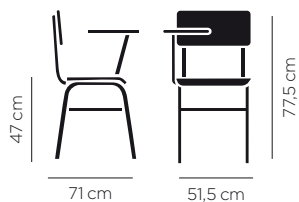

**EDU**  
Silla / Cadira / Chair / Chaise

**Ref. 978**  
Atril fijo o abatible  
Faristol fixe o abatible  
Fixed or foldable writing tablet  
Tablette écrioire fixe ou pliante.



**EDU**  
Silla / Cadira / Chair / Chaise  
**Ref. 9781**

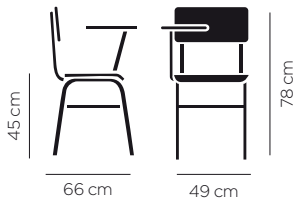

**EDU**  
 Silla / Cadira / Chair / Chaise  
 Ref. 998

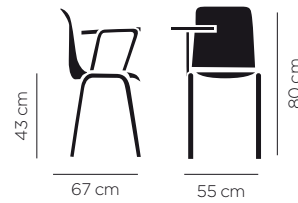

**EDU**  
 Silla / Cadira / Chair / Chaise  
 Ref. 9702  
 Atril grande  
 Faristol gran  
 Big writing pad  
 Tablette écrite grande

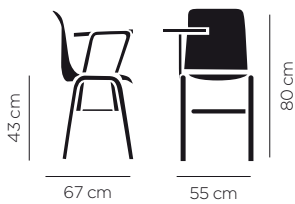

**EDU**  
 Silla / Cadira / Chair / Chaise  
 Ref. 9702  
 Rejilla opcional  
 Reixeta opcional  
 Optional book racks  
 Grille en option



# BANGCADAS







94/C

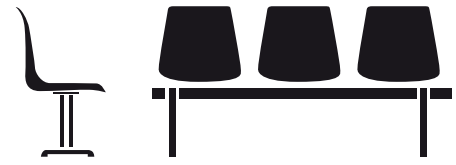

## BANCADAS

Bancada / Bancada

Multiple seating bench / siège poutre

Ref. 94



94/A



94/B



94/D



94/C

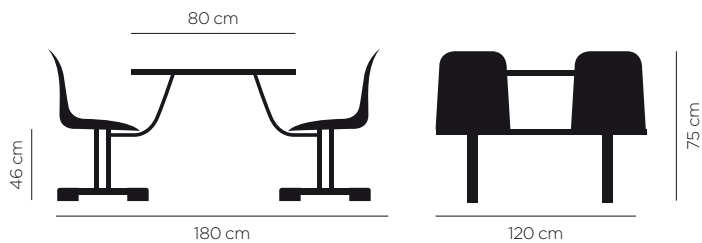

## 94AF

Mesa con asiento fijos / Taula amb seients fixes  
Table avec sièges fixes / Table with fixed seats

Ref. 94AF



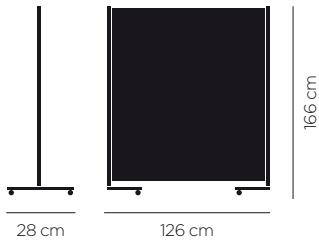

**MAMPARA**  
 Mampara divisoria / Mampara divisoria  
 Divisions / Panneau divisoire  
 Ref. 9105

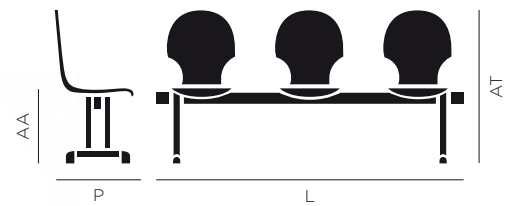

**945/A**  
 Bancada / Bancada  
 Multiple seating / Siège poutre  
 Ref. 945/A

	L				P	AA	AT
	Número de plazas						
Mod.	2	3	4	5			
<b>94 A</b>	104	158	214	269	54	45	81
<b>94 B</b>	115	170	225	280	54	45	81
<b>94 C</b>	100	155	210	265	54	45	81
<b>94 D</b>	119	174	229	284	67	45	81
<b>945 A</b>	104	158	214	269	52	45	87
<b>945 B</b>	115	170	225	280	52	45	87
<b>945 C</b>	104	158	214	269	52	45	87
<b>945 D</b>	120	175	230	285	52	45	87

Medidas en cms.



# TWIST



## TWIST

**Taburete / Tamboret  
Barstool / Tabouret**

### Ref. 3012

Asiento de madera, compacto,  
tapizado cuadrado o redondo.

Seient de fusta, compacte,  
entapissat quadrat o rodó.

Stained wood, compact,  
squared or rounded upholstered seat.

Assise bois, compact,  
garnie carré ou rond.

 5,50 kg





65 - 86 cm

45 cm

## CONIC

Taburete / Tamboret  
Barstool / Tabouret

### Ref. 1702

Taburete regulable en altura  
Tamboret regulable en alçada  
Swivel barstool  
Tabouret hauteur réglable

 6,86 kg



# CONIC





# LAB

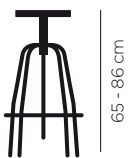

65 - 86 cm

43,5 cm

## LAB

Taburete / Tamboret  
Barstool / Tabouret

### Ref. 1701

Taburete regulable en altura  
Tamboret regulable en alçada  
Swivel barstool  
Tabouret hauteur réglable

 5,40 kg



# DUAL



## DUAL

Taburete / Tamboret  
Barstool / Tabouret

Optional:  
MONO / BICOLOR

### Ref. 1620

Taburete en acero.  
Tamboret en acer.  
Steel barstool.  
Tabouret en acier.

 5,00 kg





# MAGISTER

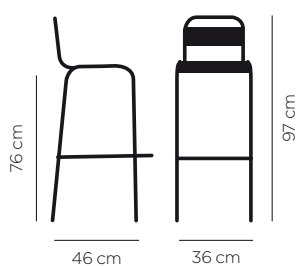

## MAGISTER

Taburete / Tamboret  
Barstool / Tabouret

### Ref. 1918F

Asiento y Respaldo formica o madera  
Seient i respattler formica o fusta  
Formica or wooden seat and back rest.  
Assise et dossier bois teinté ou Formica.

 5,14 kg

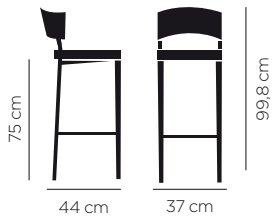

## CARLA

Taburete / Tamboret  
Barstool / Tabouret

Ref. 9585

Taburete mixto haya / acero.  
Tamboret mixte faig / acer.  
Combined barstool beech / steel.  
Tabouret mixte hêtre / acier.

7,16 kg

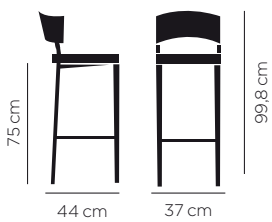

## CARLA

Taburete / Tamboret  
Barstool / Tabouret

Ref. 9585 T

Taburete mixto haya / acero.  
Tamboret mixte faig / acer.  
Combined barstool beech / steel.  
Tabouret mixte hêtre / acier.

7,78 kg



CARLA

ATENAS

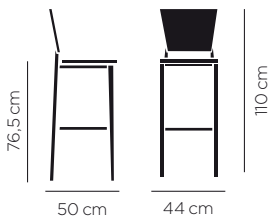

## ATENAS

Taburete / Tamboret  
Barstool / Tabouret

### Ref. 9583

Taburete mixto haya / acero.  
Tamboret mixte faig / acer.  
Combined barstool beech / steel.  
Tabouret mixte hêtre / acier.

 8,14 kg

# ETNA

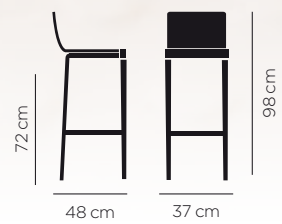

## ETNA

Taburete / Tamboret  
Barstool / Tabouret

### Ref. 9579

Taburete mixto haya / acero.  
Tamboret mixte faig / acer.  
Combined barstool beech / steel.  
Tabouret mixte hêtre / acier.

 7,34 kg

# SUSHI

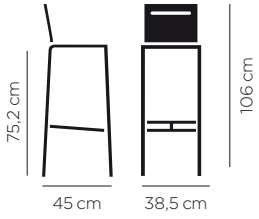

**SUSHI**  
Taburete / Tamboret  
Barstool / Tabouret

Ref. 9573

 5,64 kg





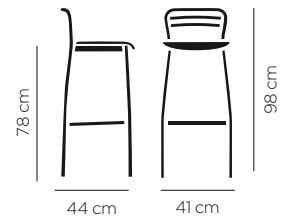

## OLIMPIA

Taburete / Tamboret  
Barstool / Tabouret

### Ref. 9433 (metallic)

Taburete mixto acero.  
Tamboret mixte acer.  
Combined barstool steel.  
Tabouret mixte acier.

📦 5,84 kg

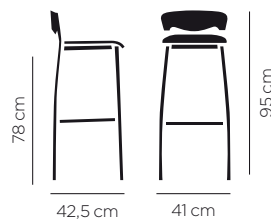

## OLIMPIA

Taburete / Tamboret  
Barstool / Tabouret

### Ref. 9433 (wood)

Taburete mixto haya / acero.  
Tamboret mixte faig / acer.  
Combined barstool beech / steel.  
Tabouret mixte hêtre / acier.

📦 5,40 kg





# OLIMPIA

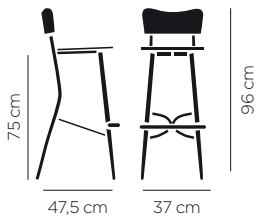

**HELENA**  
**Taburete / Tamboret**  
**Barstool / Tabouret**

**Ref. 9581/R**

Taburete apoyapiés cromado.  
 Tamboret recolçapeus cromat.  
 Chrome feetrest barstool.  
 Tabouret Repose-pieds chromé.

 5,50 kg



**HELENA**  
**Taburete / Tamboret**  
**Barstool / Tabouret**

**Ref. 9580**

Taburete mixto haya / acero.  
 Tamboret mixte faig / acer.  
 Combined barstool beech / steel.  
 Tabouret mixte hêtre / acier.

 5,00 kg

# HELENA



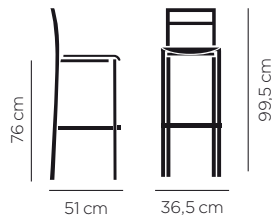

### CAPRI

**Taburete / Tamboret  
Barstool / Tabouret**

**Ref. 9575 T**

Taburete mixto tapizado / acero.  
Tamboret mixte entapissat / acer.  
Combined barstool upholstered seat / steel.  
Tabouret mixte assise garnie / acier.

 7,42 kg

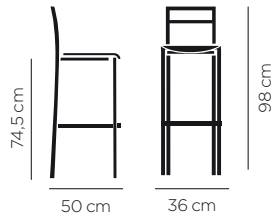

### CAPRI

**Taburete / Tamboret  
Barstool / Tabouret**

**Ref. 9574**

Taburete mixto haya / acero.  
Tamboret mixte faig / acer.  
Combined barstool beech / steel.  
Tabouret mixte hêtre / acier.

 8,20 kg

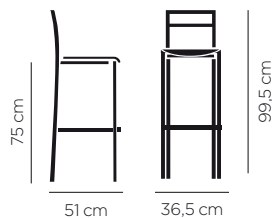

### CAPRI

**Taburete / Tamboret  
Barstool / Tabouret**

**Ref. 9575**

Taburete mixto haya / acero.  
Tamboret mixte faig / acer.  
Combined barstool beech / steel.  
Tabouret mixte hêtre / acier.

 7,42 kg

# CAPRI

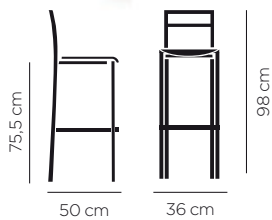

## CAPRI

Taburete / Tamboret  
Barstool / Tabouret

### Ref. 9574 T

Taburete mixto haya / acero. Asiento tapizado.  
Tamboret mixte faig / acer. Seient entapissat.  
Combined barstool beech / steel. Upholstered seat.  
Tabouret mixte hêtre / acier. Assise garnie.

 8,62 kg





LIDO

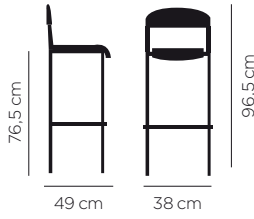

**LIDO**  
Taburete / Tamboret  
Barstool / Tabouret

**Ref. 9950**

Taburete mixto haya / acero.  
Tamboret mixte faig / acer.  
Combined barstool beech / steel.  
Tabouret mixte hêtre / acier.

 5,20 kg





**9588**  
**Taburete / Tamboret**  
**Barstool / Tabouret**

**Ref. 9588**

Asiento de madera.  
Seient de fusta.  
Wooden seat.  
Assise hêtre teinté.

 4,80 kg



**9588**  
**Taburete / Tamboret**  
**Barstool / Tabouret**

**Ref. 9588**

Asiento compacto.  
Seient compacte.  
Compact seat.  
Assise compact.

 4,80 kg





# CUBICA

# GIRATORIO

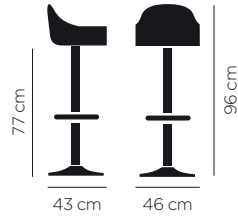

## GIRATORIO Taburete / Tamboret Barstool / Tabouret

**Ref. 1294**

Taburete giratorio inox/latón  
Tamboret giratori inox/llautó  
Swivel stainless steel/brass barstool  
Tabouret inox/latoné giratoire

 16 kg

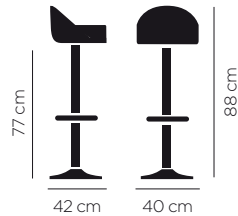

## GIRATORIO Taburete / Tamboret Barstool / Tabouret

**Ref. 1292**

Taburete giratorio inox/latón  
Tamboret giratori inox/llautó  
Swivel stainless steel/brass barstool  
Tabouret inox/latoné giratoire

 16 kg



## GIRATORIO Taburete / Tamboret Barstool / Tabouret

**Ref. 1290**

Taburete giratorio inox/latón  
Tamboret giratori inox/llautó  
Swivel stainless steel/brass barstool  
Tabouret inox/latoné giratoire

 15 kg



33 cm

76,5 cm

## SQUARE

Taburete / Tamboret  
Barstool / Tabouret

**Ref. 9587**

Asiento tapizado  
Seient entapissat  
Upholstered seat  
Assisse garnie

 6,34 kg



33 cm

50 cm

## SQUARE

Taburete / Tamboret  
Barstool / Tabouret

**Ref. 9587B**

Asiento tapizado  
Seient entapissat  
Upholstered seat  
Assisse garnie

 5,20 kg



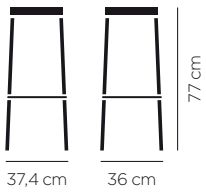

**1600**  
**Taburete / Tamboret**  
**Barstool / Tabouret**

**Ref. 1600**  
 Asiento de madera.  
 Seient de fusta.  
 Wooden seat.  
 Assise hêtre teinté.

 5,56 kg

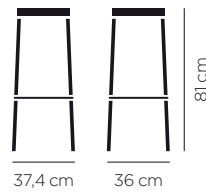

**1600**  
**Taburete / Tamboret**  
**Barstool / Tabouret**

**Ref. 1600**  
 Asiento tapizado con banda.  
 Seient entapissat amb banda.  
 Thick upholstered seat.  
 Assise gross.

 5,62 kg

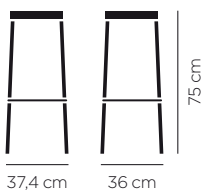

**1600**  
**Taburete / Tamboret**  
**Barstool / Tabouret**

**Ref. 1600**  
 Asiento compacto.  
 Seient compacte.  
 Compact seat.  
 Assise compact.

 3,92 kg



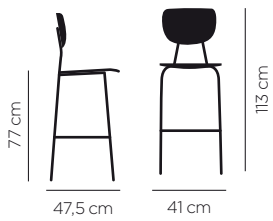

## VINT

Taburete / Tamboret  
Barstool / Tabouret

### Ref. V520

Asiento y respaldo madera tintada.  
Seient i respàtller de fusta tintada.  
Stained wooden seat and back rest.  
Assise et dossier bois teinté.

 6,34 kg





**1630**  
**Taburete / Tamboret**  
**Barstool / Tabouret**

**Ref. 1630**  
Asiento tapizado con banda.  
Seient entapissat amb banda.  
Thick upholstered seat.  
Assise gross.

 5,56 kg



**1630**  
**Taburete / Tamboret**  
**Barstool / Tabouret**

**Ref. 1630**  
Asiento de madera.  
Seient de fusta.  
Wooden seat.  
Assise hêtre teinté.

 6,42 kg

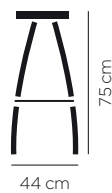

**1630**  
**Taburete / Tamboret**  
**Barstool / Tabouret**

**Ref. 1630**  
Asiento compacto.  
Seient compacte.  
Compact seat.  
Assise compact.

 4,78 kg





**1640**  
**Taburete / Tamboret**  
**Barstool / Tabouret**

**Ref. 1640**  
Asiento de madera.  
Seient de fusta.  
Wooden seat.  
Assise hêtre teinté.

 6,42 kg



**1640**  
**Taburete / Tamboret**  
**Barstool / Tabouret**

**Ref. 1640**  
Asiento tapizado con banda.  
Seient entapissat amb banda.  
Thick upholstered seat.  
Assise gross.

 5,56 kg



**1640**  
**Taburete / Tamboret**  
**Barstool / Tabouret**

**Ref. 1640**  
Asiento compacto.  
Seient compacte.  
Compact seat.  
Assise compact.

 4,78 kg



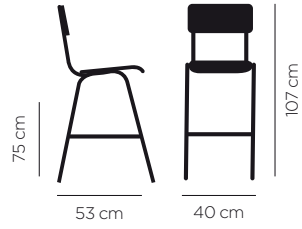

## 1099F

Taburete / Tamboret  
Barstool / Tabouret

### Ref. 1099F

Asiento y respaldo formica.  
Seient i respalller de formica.  
Formica seat and back rest.  
Assise et dossier formica.

 5,70 kg





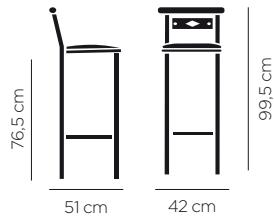

**2064**  
**Taburete / Tamboret**  
**Barstool / Tabouret**

**Ref. 2064**  
 Taburete tapizado.  
 Tamboret entapissat.  
 Upholstered barstool.  
 Tabouret garnie.

 7,48 kg

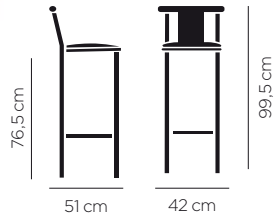

**1064**  
**Taburete / Tamboret**  
**Barstool / Tabouret**

**Ref. 1064**  
 Taburete tapizado.  
 Tamboret entapissat.  
 Upholstered barstool.  
 Tabouret garnie.

 8,16 kg

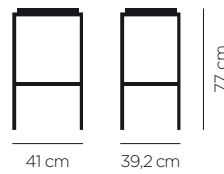

**9989**  
**Taburete / Tamboret**  
**Barstool / Tabouret**

**Ref. 9989**  
 Asiento madera  
 Seient de fusta  
 Wooden seat  
 Assise hêtre teinté

 4,58 kg

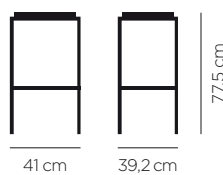

**9989T**  
**Taburete / Tamboret**  
**Barstool / Tabouret**

**Ref. 9989T**  
 Asiento madera + tapizado  
 Seient de fusta + entapissat  
 Wooden seat + upholstered pad  
 Assise hêtre teinté + garnisage

 4,86 kg



**1001**  
**Taburete / Tamboret**  
**Barstool / Tabouret**

**Ref. 1001**

Asiento tapizado con banda.  
Seient entapissat amb banda.  
Thik upholstered seat.  
Assise gross.

 5,32 kg



**1001**  
**Taburete / Tamboret**  
**Barstool / Tabouret**

**Ref. 1001**

Asiento madera / integral  
Seient de fusta / integral  
Wooden / integral seat  
Assise hêtre teinté / integral

 4,36 kg



**1002**  
**Taburete / Tamboret**  
**Barstool / Tabouret**

**Ref. 1002**  
Taburete metálico.  
Tamboret metàl·lic.  
Metal barstool.  
Tabouret metal.

 4,44 kg

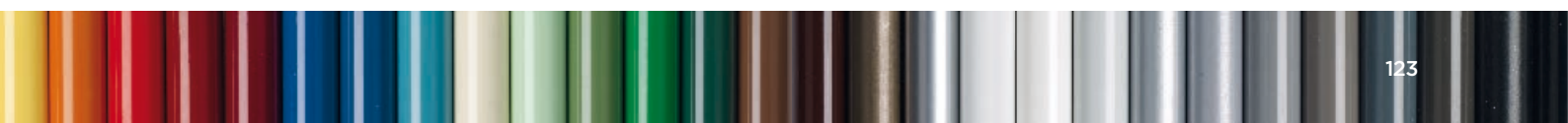

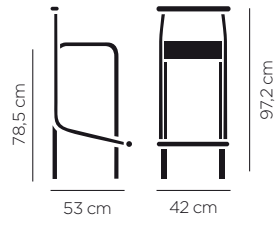

**1500**  
**Taburete / Tamboret**  
**Barstool / Tabouret**

**Ref. 1500**  
Taburete metálico.  
Tamboret metàl·lic.  
Metal Barstool.  
Tabouret metal.

 7,52 kg



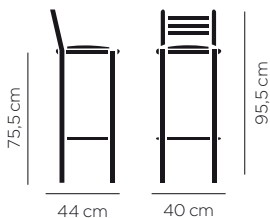

**1061**  
**Taburete / Tamboret**  
**Barstool / Tabouret**

**Ref. 1061**  
 Asiento tapizado.  
 Seient entapissat.  
 Upholstered seat.  
 Assise garnie.

 6,44 kg

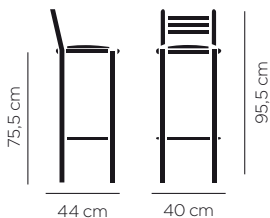

**1061**  
**Taburete / Tamboret**  
**Barstool / Tabouret**

**Ref. 1061**  
 Asiento de madera.  
 Seient de fusta.  
 Wooden seat.  
 Assise hêtre teinté.

 5,96 kg



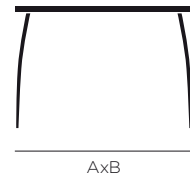
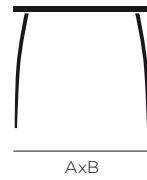

75 cm

**2006**  
**Mesa / Taula**  
**Table / Table**  
**Ref. 2006**





Dimensiones y acabados encimeras según tarifa.  
Dimensions i acabats segons tarifa.  
See Price lists for tabletop finishings and dimensions.  
Regardez tarif pour finitions et dimensions des plateaux.

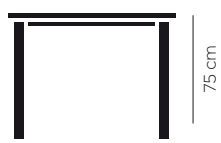

AxB

**920**

Mesa / Taula / Table / Table

Ref. 920





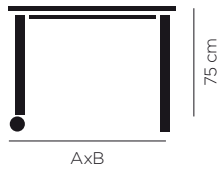
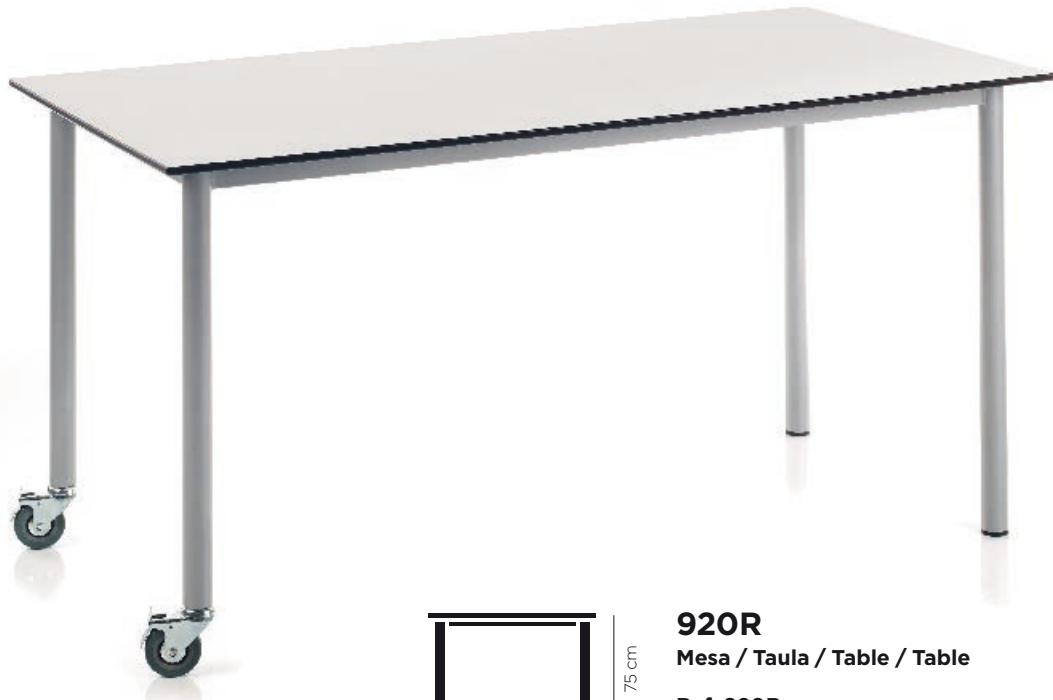

**920R**  
 Mesa / Taula / Table / Table  
 Ref. 920R

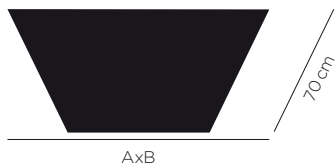
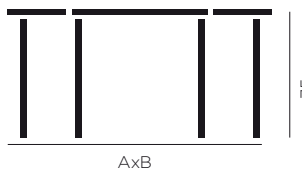

**9390**  
 Mesa / Taula / Table / Table  
 Ref. 9390

Dimensiones y acabados encimeras según tarifa.  
 Dimensions i acabats segons tarifa.  
 See Price lists for tabletop finishings and dimensions.  
 Regardez tarif pour finitions et dimensions des plateaux.



75 cm

**2510**  
Mesa / Taula / Table / Table  
Ref. 2510



75 cm

**2500**  
Mesa / Taula / Table / Table  
Ref. 2500



2500

2510

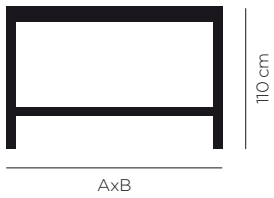

## 2510AL

Mesa / Taula / Table / Table

Ref. 2510AL



Dimensiones y acabados encimeras según tarifa.  
Dimensions i acabats segons tarifa.  
See Price lists for tabletop finishings and dimensions.  
Regardez tarif pour finitions et dimensions des plateaux.

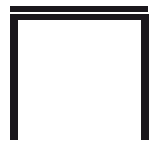

AxB



AxB

75 cm

**2520**  
**Mesa / Taula**  
**Table / Table**  
**Ref. 2520**





80-90 cm

80-160 cm

## TWIN

Mesa / Taula / Table / Table

Ref. 2026





73/76 cm

47 cm

## PARIS

Mesa / Taula / Table / Table

### Ref. 2003/4

Base de fundición hierro.  
Base de fosa de ferro.  
Cast iron base.  
Base fonte.



# PARIS

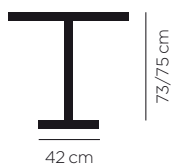

42 cm

73/75 cm

## 4150

Mesa / Taula / Table / Table

### Ref. 4150

Base de fundición hierro.  
Base de fosa de ferro.  
Cast iron base.  
Base fonte.





75 cm

**2402**  
Mesa / Taula  
Table / Table  
Ref. 2402

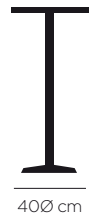

110 cm

**2422**  
Mesa / Taula  
Table / Table  
Ref. 2422



75 cm

**4130**  
Mesa / Taula  
Table / Table  
Ref. 4130







**4120**  
Mesa / Taula  
Table / Table  
Ref. 4120



**4120AL**  
Mesa / Taula  
Table / Table  
Ref. 4120AL

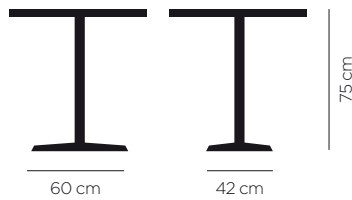

**4120-1**  
Mesa / Taula  
Table / Table  
Ref. 4120-1

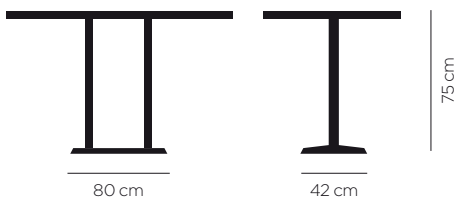

**4120-2**  
Mesa / Taula  
Table / Table  
Ref. 4120-2



**4470 AL**

Mesa / Taula / Table / Table

**Ref. 4470 AL**

Base redonda + columna cilíndrica  
Base rodona + columna cilíndrica  
Round base + cylinder column  
Embase ronde + colonne ronde



**4475**

Mesa / Taula / Table / Table

**Ref. 4475**

Base cuadrada + columna cilíndrica  
Base quadrada + columna cilíndrica  
Squared base + cylinder column  
Embase carré + colonne ronde



**4470**

Mesa / Taula / Table / Table

**Ref. 4470**

Base redonda + columna cilíndrica  
Base rodona + columna cilíndrica  
Round base + cylinder column  
Embase ronde + colonne ronde





### 4480

Mesa / Taula / Table / Table

**Ref. 4480**

Base cuadrada + columna cuadrada  
Base quadrada + columna quadrada  
Squared base + squared column  
Embase carré + colonne carré



### 4480 AL

Mesa / Taula / Table / Table

**Ref. 4480 AL**

Base cuadrada + columna cuadrada  
Base quadrada + columna quadrada  
Squared base + squared column  
Embase carré + colonne carré

### 4490

Mesa / Taula / Table / Table

**Ref. 4490**

Base rectangular + columnas cuadradas  
Base rectangular + columnes quadrades  
Rectangular base + squared columns  
Embase rectangulaire + colonnes carrés



### 4490/2R

Mesa / Taula / Table / Table

**Ref. 4490/2R**

Base rectangular + columnas cilíndricas  
Base rectangular + columnes cilíndriques  
Rectangular base + cylinder columns  
Embase rectangulaire + colonnes rondes

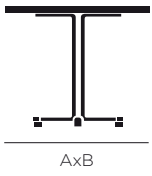

**2027**  
**Mesa / Taula**  
**Table / Table**  
**Ref. 2027**





**2005**  
**Mesa / Taula**  
**Table / Table**  
**Ref. 2005**



**2004**  
**Mesa / Taula**  
**Table / Table**  
**Ref. 2004**

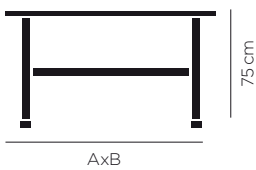

**2007**  
**Mesa / Taula**  
**Table / Table**  
**Ref. 2007**



Dimensiones y acabados encimeras según tarifa.  
 Dimensions i acabats segons tarifa.  
 See Price lists for tabletop finishings and dimensions.  
 Regardez tarif pour finitions et dimensions des plateaux.



**923D**  
Mesa / Taula  
Table / Table  
Ref. 923D



**2427**  
Mesa / Taula  
Table / Table  
Ref. 2427

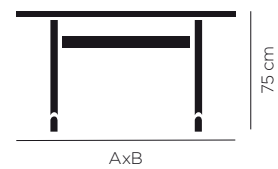

**2227/S**  
Mesa / Taula  
Table / Table  
Ref. 2227/S

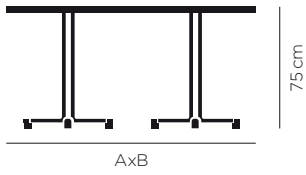

**2429**  
Mesa / Taula  
Table / Table

Ref. 2429



Dimensiones y acabados encimeras según tarifa.  
Dimensions i acabats segons tarifa.  
See Price lists for tabletop finishings and dimensions.  
Regardez tarif pour finitions et dimensions des plateaux.

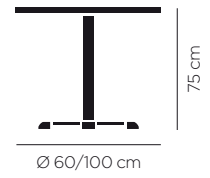

**2029**  
Mesa / Taula  
Table / Table  
Ref. 2029

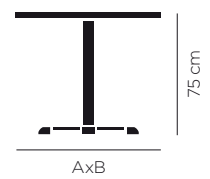

**2029**  
Mesa / Taula  
Table / Table  
Ref. 2029



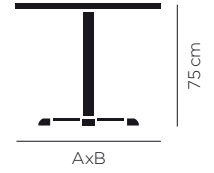

**2029**  
**Mesa / Taula**  
**Table / Table**  
**Ref. 2029**

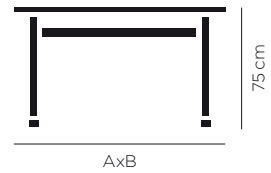

**2009NT**  
**Mesa / Taula**  
**Table / Table**  
**Ref. 2009NT**



Dimensiones y acabados encimeras según tarifa.  
Dimensions i acabats segons tarifa.  
See Price lists for tabletop finishings and dimensions.  
Regardez tarif pour finitions et dimensions des plateaux.



**4027**

Mesa / Taula / Table / Table

Ref. 4027

Ø60/70 cm





Ø60/70 cm

110 cm

**4027 AL**  
Mesa / Taula / Table / Table  
Ref. 4027 AL



Ø60/70 cm

110 cm

**2029 AL**  
Mesa / Taula / Table / Table  
Ref. 2029 AL



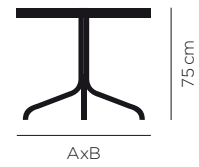

**2025**  
Mesa / Taula / Table / Table  
Ref. 2025



Dimensiones y acabados encimeras según tarifa  
Dimensions i acabats segons tarifa  
See Price lists for tabletop finishings and dimensions  
Regardez tarif pour finitions et dimensions des plateaux

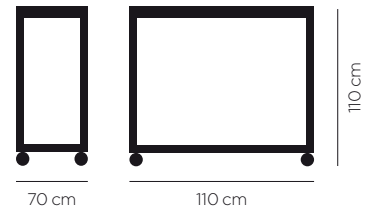

**2500 AR**  
Mesa con ruedas  
Taula amb rodes  
Table with roller wheels  
Table avec roues glissantes

Ref. 2500 AR



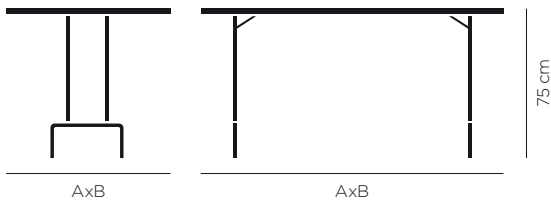

**PLEGABLES**

Mesa / Taula  
Table / Table

Ref. 4109

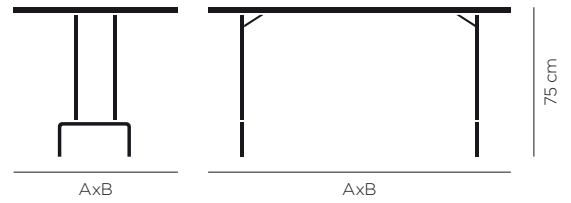

**PLEGABLES**

Mesa / Taula  
Table / Table

Ref. 4109 P



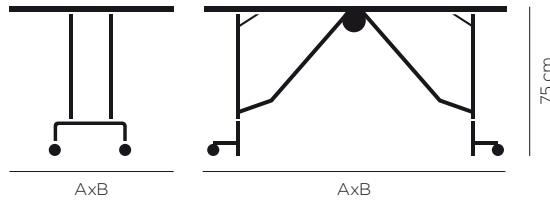

**PLEGABLES**  
 Mesa / Taula  
 Table / Table  
 Ref. 4109CR

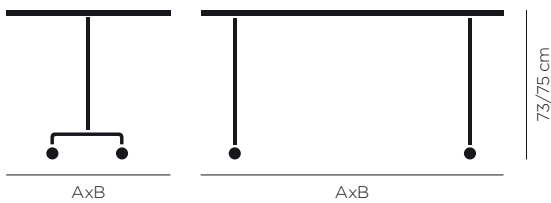
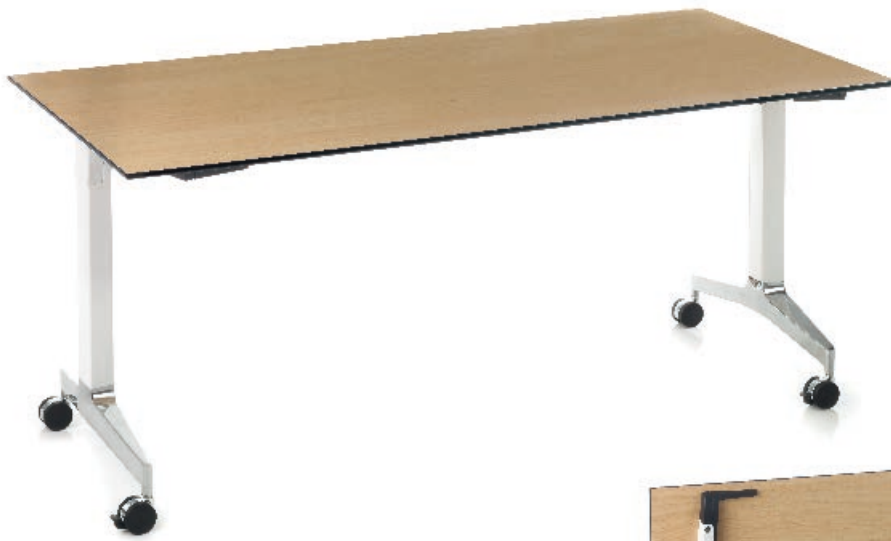

**PLEGABLES**  
 Mesa / Taula / Table / Table  
 Ref. 4108



Dimensiones y acabados encimeras según tarifa.  
 Dimensions i acabats segons tarifa.  
 See Price lists for tabletop finishings and dimensions.  
 Regardez tarif pour finitions et dimensions des plateaux.

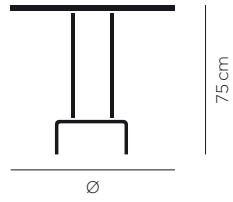

**PLEGABLES**

Mesa / Taula  
Table / Table

Ref. 4109 RP





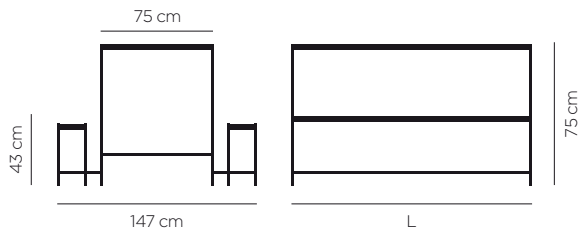

## PLEGABLES

Mesa / Taula / Table / Table

Ref. PLEC



Dimensiones y acabados encimeras según tarifa.  
 Dimensions i acabats segons tarifa.  
 See Price lists for tabletop finishings and dimensions.  
 Regardez tarif pour finitions et dimensions des plateaux.

# PVC/ABS CANTOS / CANTELLS / EDGES / CHANTS / KANTEN

22/30/45 mm

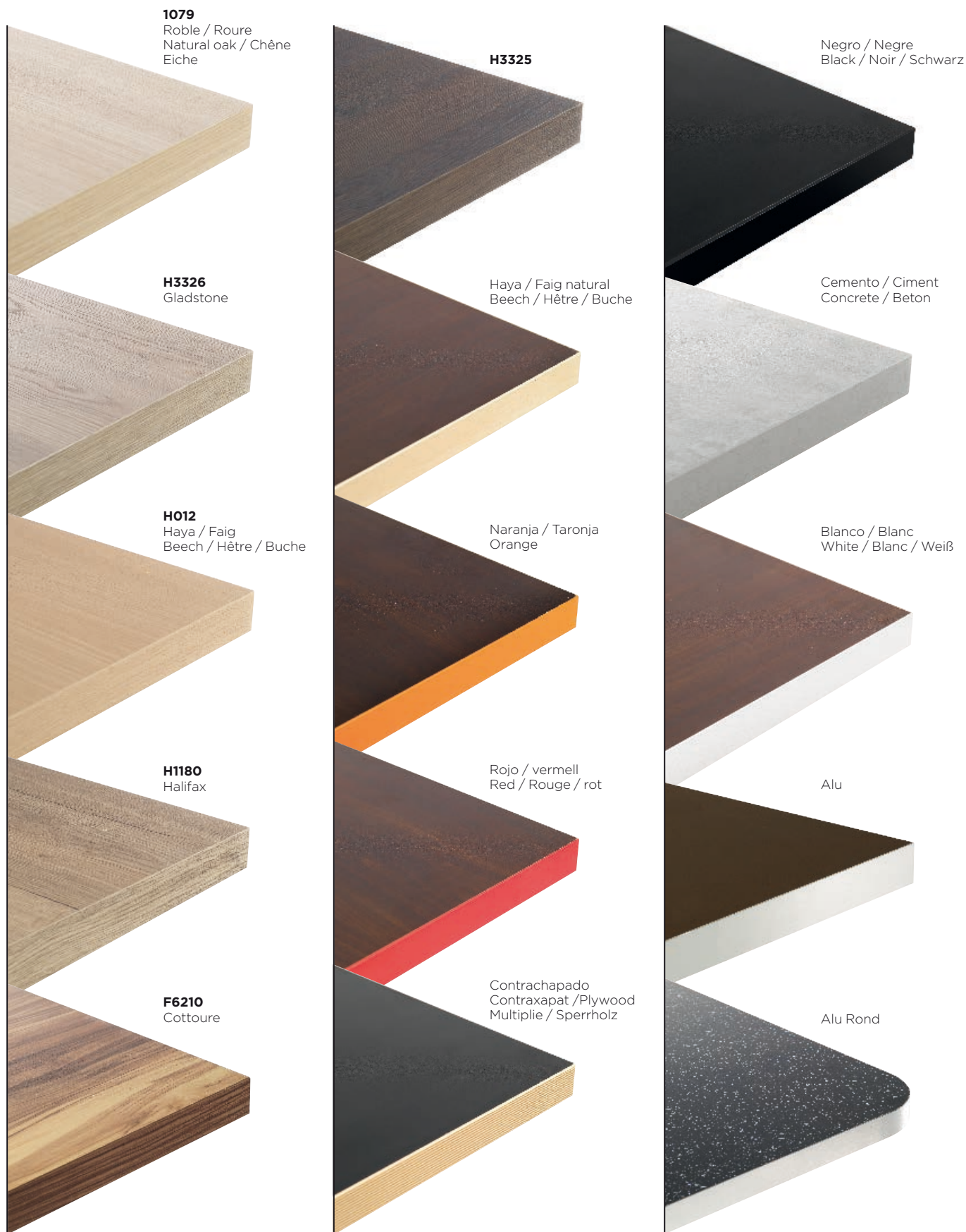

La reproducción fotográfica de los diferentes acabados puede dar tonalidades no exactas al 100%, sino aproximadas del producto en sí. (tela, pinturas, plásticos, estratificados, maderas). Ante dudas rogamos soliciten muestra real.  
La reproducció fotogràfica de les diferents terminacions pot resultar no del tot fidel al 100% a la realitat, sino aproximades al producte en si mateix. (Teles, pintures, estratificats i fustes). Davant el dubte preguem sol·licitin mostra real.  
The photographs of the different finishes may not reflect the exact colour tone of the actual product (e.g. the fabric, paints, plastics, laminates and/or wood). Should you have any concerns, please request a sample.

# TAPAS / TAULELLS / TABLE TOPS / PLATEAUX / TISCHPLATTEN

22/30/45/60 cm

Cantos de madera / Cantells de fusta  
Wooden edges / Chants en bois  
Kanten aus Holz



**\* 12 mm**  
Blanco / Blanc / White / Blanc / Weiss  
Negro / Negre / Black / Noir / Schwarz  
Gris / Gris / Grey / Gris / Grau  
Haya / Faig / Beech / Hêtre / Buche  
Rojo / Vermell / Red / Rouge / Rot  
Amarillo / Groc / Yellow / Jaune / Gelb  
Azul / Blau / Blue / Bleu / Blau  
Pistacho / Pistatxo / Pistaxie / Pistachio / Grün

**\*\* 10 mm**  
Blanco / Blanc / White / Blanc / Weiss  
Negro / Negre / Black / Noir / Schwarz  
Haya / Faig / Beech / Hêtre / Buche  
Oxido / Oxid / Rusty / Oxide / Oxid

19 / 22 / 30 / 45 mm recto / recte / flat / droit / gerade  
curvo / arrodonit / rond / rounded / gebogen

60 mm recto / recte / flat / droit / gerade

# TAPIZADOS / ENTAPISSATS / UPHOLSTERIES / TAPISSERIES

## GENIUS

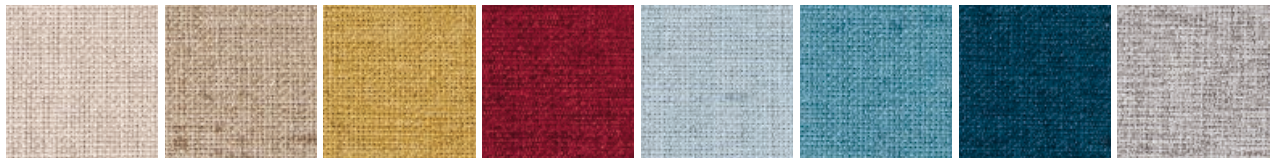

GENIUS LINEN GENIUS BEIGE GENIUS BANANA GENIUS ROUGE GENIUS ICE GENIUS OCEAN GENIUS PEACOCK GENIUS SILVER

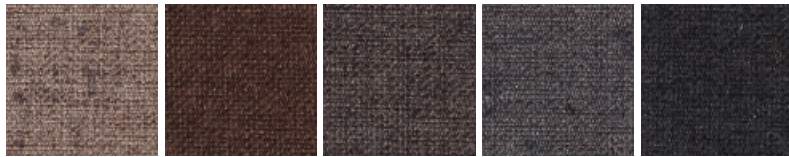

GENIUS MOCHA GENIUS CHOCOLATE GENIUS TAUPE GENIUS CHARCOAL GENIUS SLATE

## KUBIKS

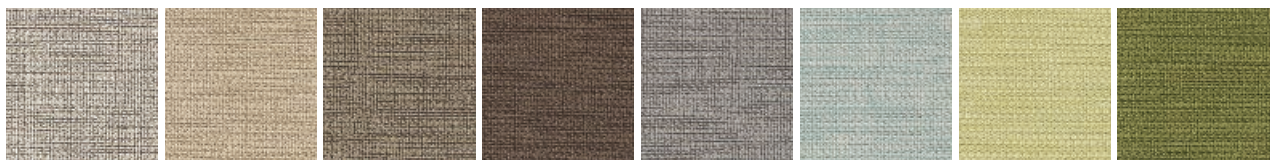

KUBIKS 3 KUBIKS 4 KUBIKS 11 KUBIKS 7 KUBIKS 10 KUBIKS 18 KUBIKS 8 KUBIKS 13

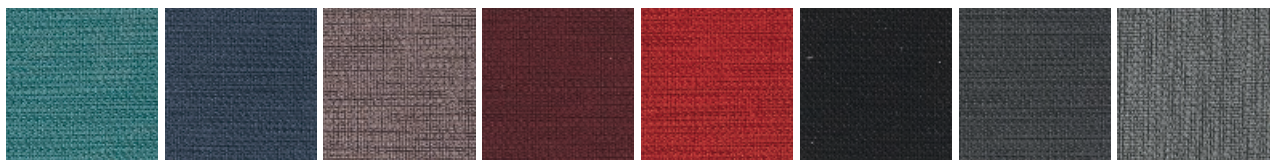

KUBIKS 12 KUBIKS 14 KUBIKS 15 KUBIKS 6 KUBIKS 17 KUBIKS 1 KUBIKS 5 KUBIKS 100

## RAINBOW

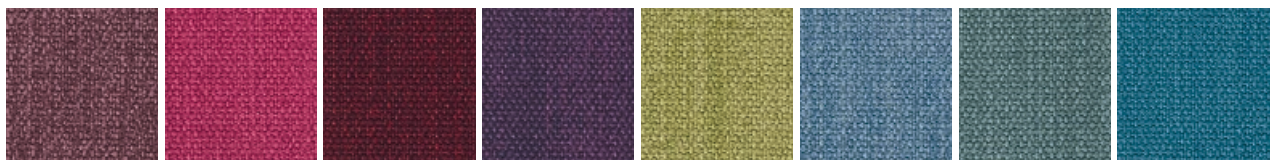

RAINBOW 95 RAINBOW 93 RAINBOW 96 RAINBOW 94 RAINBOW 91 RAINBOW 89 RAINBOW 87 RAINBOW 97



RAINBOW 88 RAINBOW 98 RAINBOW 86 RAINBOW 90 RAINBOW 92

## ELEGANT



ELEGANT MARFIL ELEGANT SAND ELEGANT BEIGE ELEGANT IRON ELEGANT PLANET ELEGANT STEEL ELEGANT NATURE ELEGANT OCEAN

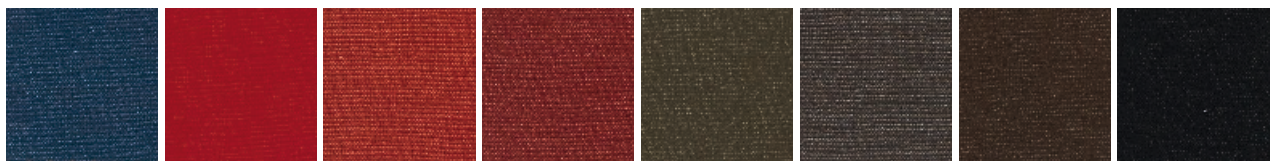

ELEGANT MARINE ELEGANT DIAVOLO ELEGANT APACHE ELEGANT OXID ELEGANT SAVAGE ELEGANT COVALD ELEGANT CACAO ELEGANT BLACK

La reproducción fotográfica de los diferentes acabados puede dar tonalidades no exactas al 100%, sino aproximadas del producto en sí. (tela, pinturas, plásticos, estratificados, maderas). Ante dudas rogamos soliciten muestra real.  
 La reproducció fotogràfica de les diferents terminacions pot resultar no del tot fidel al 100% a la realitat, sino aproximades al producte en si mateix. (Teles, pintures, estratificats i fustes). Davant el dubte preguem sol·licitin mostra real.  
 The photographs of the different finishes may not reflect the exact colour tone of the actual product (e.g. the fabric, paints, plastics, laminates and/or wood). Should you have any concerns, please request a sample.

## ARTIST



ARTIST MARFIL ARTIST SAND ARTIST BEIGE ARTIST IRON ARTIST PLANET ARTIST STEEL ARTIST NATURE ARTIST OCEAN

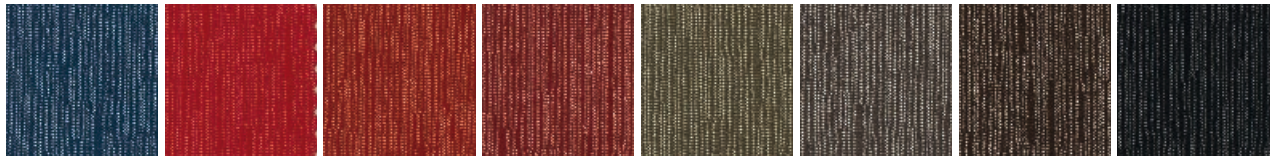

ARTIST MARINE ARTIST DIAVOLO ARTIST APACHE ARTIST OXID ARTIST SAVAGE ARTIST COVALD ARTIST CACAO ARTIST BLACK

## OSETIA - DANDINI

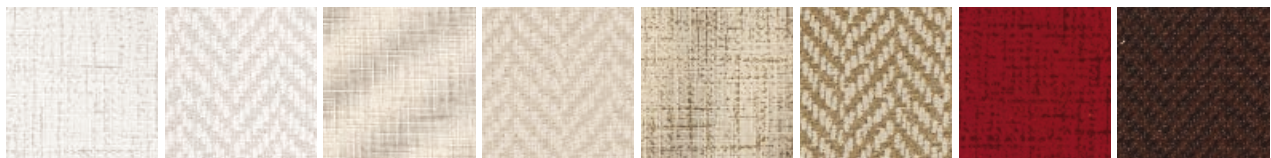

OSETIA FOXY DANDINI FOXY OSETIA CREAM DANDINI CREAM OSETIA BEIGE DANDINI BEIGE OSETIA SCARLET DANDINI CONGO

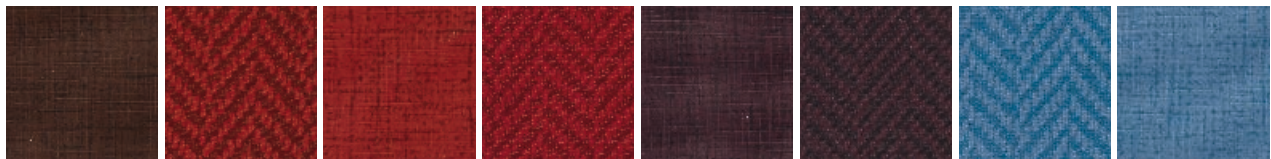

OSETIA CONGO DANDINI LUCIE OSETIA LUCIE DANDINI SCARLET OSETIA CHERIE DANDINI CHERIE DANDINI MATINEE OSETIA MATINEE

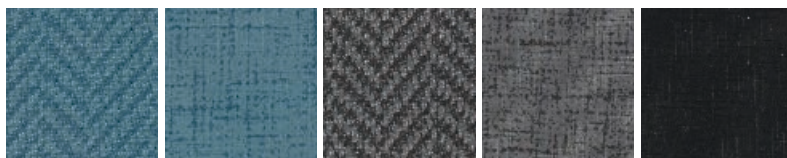

DANDINI INFINITY OSETIA INFINITY DANDINI GREKO OSETIA GREKO OSETIA BLAKS

## ATLANTIS



ATLANTIS WHITE ATLANTIS SKIN ATLANTIS BEIGE ATLANTIS RED ATLANTIS GARNET ATLANTIS NEWBLUE ATLANTIS DARK BLUE ATLANTIS GREY



ATLANTIS DARK GREY ATLANTIS YELLOW ATLANTIS ORANGE ATLANTIS LILA ATLANTIS SKY ATLANTIS JADE ATLANTIS FOREST ATLANTIS CUIR

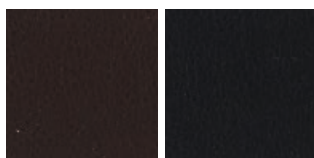

ATLANTIS CHOCOLATE ATLANTIS BLACK

# TAPIZADOS / ENTAPISSATS / UPHOLSTERIES / TAPISSERIES

## CORFÚ

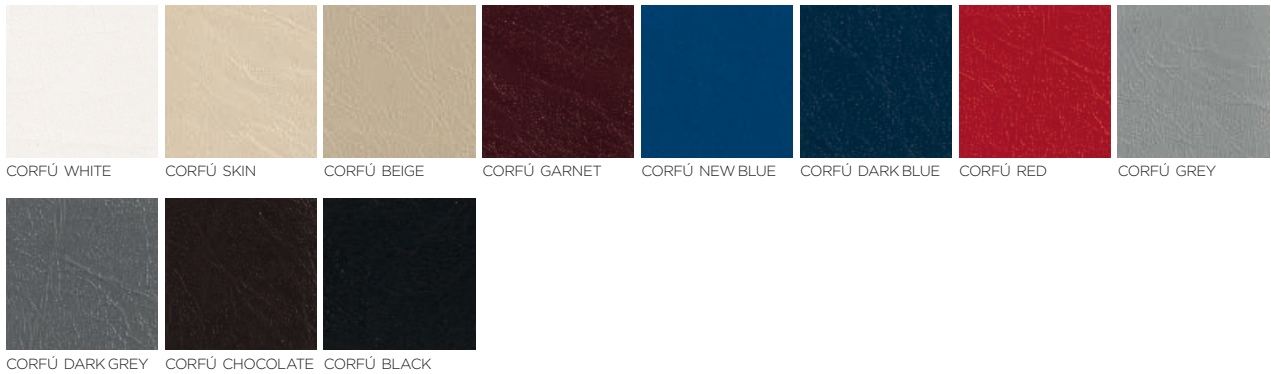

## ELECTRA



# PINTURA EPOXI / COLORIS METAL EPOXY POWDER COATED COLOURS

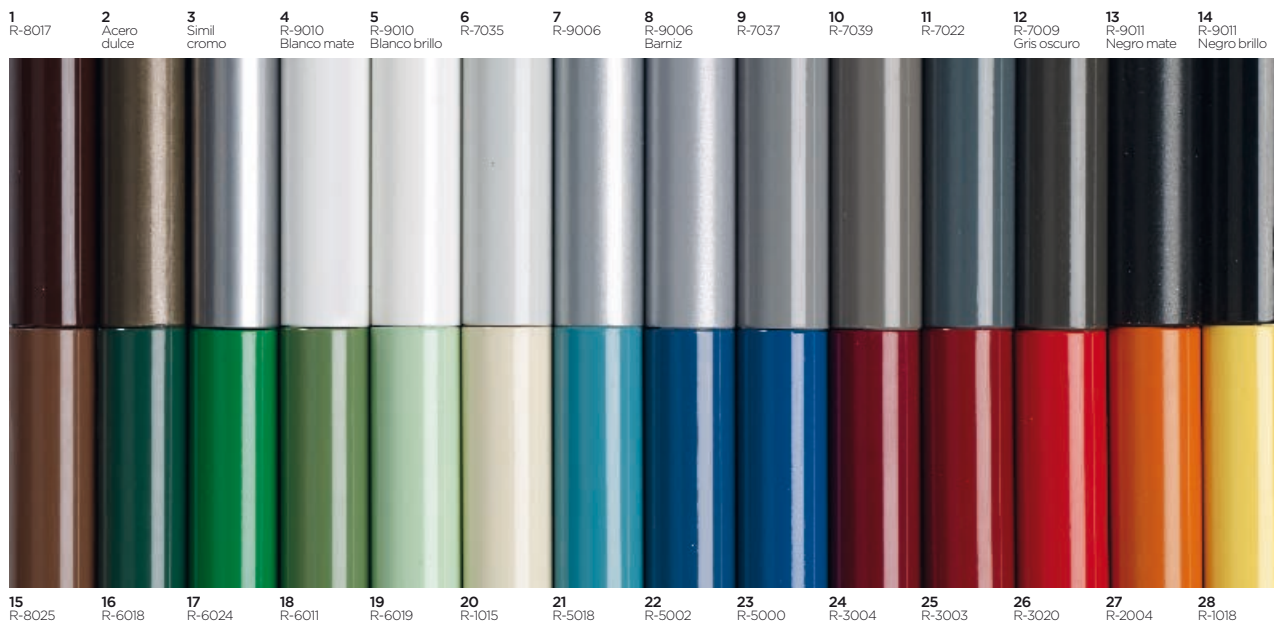

La reproducción fotográfica de los diferentes acabados puede dar tonalidades no exactas al 100%, sino aproximadas del producto en sí. (tela, pinturas, plásticos, estratificados, maderas). Ante dudas rogamos soliciten muestra real.  
La reproducció fotogràfica de les diferents terminacions pot resultar no del tot fidel al 100% a la realitat, sino aproximades al producte en si mateix. (Teles, pintures, estratificats i fustes). Davant el dubte preguem sol·licitin mostra real.  
The photographs of the different finishes may not reflect the exact colour tone of the actual product (e.g. the fabric, paints, plastics, laminates and/or wood). Should you have any concerns, please request a sample.

# FORMICA / LAMINATES / STRATIFIÉS / LAMINATEN



## MADERA / FUSTA / WOOD BOIS / HOLZ

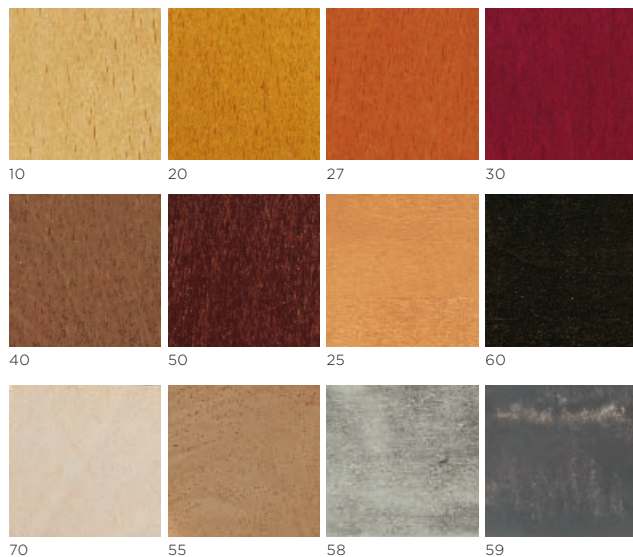

## INTEGRAL Ø 34/ 38 CM





**CROM-2, S.A.**

Fábrica y oficinas

Ctra. N-II, km 454 - Pol. Ind. Galileo C/B  
25180 Alcarràs (Lleida)

Tel. 973 795 030 · Fax 973 795 031

[www.crom2.com](http://www.crom2.com) · [ventas@crom2.com](mailto:ventas@crom2.com)